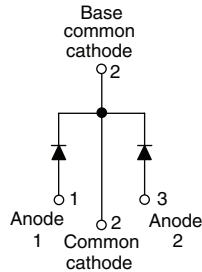

## Ultrafast Rectifier, 2 x 35 A FRED Pt™

**TO-218**

### FEATURES

- Two common-cathode diodes
- Ultrafast reverse recovery
- Ultrafast reverse recovery current shape
- Low forward voltage drop
- Low leakage current
- Optimized for power conversion: welding and industrial SMPS applications
- Up to 175 °C operating junction temperature
- Designed and qualified for industrial level

### DESCRIPTION

The 70CRU02 integrates two state of the art Vishay HPP ultrafast recovery rectifiers in the common-cathode configuration. The planar structure of the diodes, and the platinum doping life-time control, provide a ultrasoft recovery current shape, together with the best overall performance, ruggedness and reliability characteristics. These devices are thus intended for high frequency applications in which the switching energy is designed not to be predominant portion of the total energy, such as in the output rectification stage of welding machines, SMPS, dc-to-dc converters. Their extremely optimized stored charge and low recovery current reduce both over-dissipation in the switching elements (and snubbers) and EMI/RFI.

### PRODUCT SUMMARY

$I_{F(AV)}$ at $T_C = 145\text{ °C}$	2 x 35 A
$V_R$	200 V
$t_{rr}$	28 ns

### ABSOLUTE MAXIMUM RATINGS

PARAMETER	SYMBOL	TEST CONDITIONS	MAX.	UNITS
Continuous forward current per diode	$I_{F(AV)}$	$T_C = 145\text{ °C}$	35	A
Cathode to anode voltage	$V_R$		200	V
Single pulse forward current per diode	$I_{FSM}$	$T_C = 25\text{ °C}$	300	A
Maximum power dissipation per module	$P_D$	$T_C = 100\text{ °C}$	67	W
Operating junction and storage temperatures	$T_J, T_{Stg}$		- 55 to 175	°C

### ELECTRICAL SPECIFICATIONS PER DIODE ( $T_J = 25\text{ °C}$ unless otherwise specified)

PARAMETER	SYMBOL	TEST CONDITIONS	MIN.	TYP.	MAX.	UNITS
Breakdown voltage, blocking voltage	$V_{BR}, V_R$	$I_R = 60\text{ }\mu\text{A}$	200	-	-	V
Forward voltage	$V_F$	$I_F = 35\text{ A}$	-	0.95	1.09	
		$I_F = 35\text{ A}, T_J = 125\text{ °C}$	-	0.9	1.0	
		$I_F = 35\text{ A}, T_J = 175\text{ °C}$	-	0.85	0.9	
Reverse leakage current	$I_R$	$V_R = V_R\text{ rated}$	-	-	60	$\mu\text{A}$
		$T_J = 150\text{ °C}, V_R = V_R\text{ rated}$	-	-	2	mA
Junction capacitance	$C_T$	$V_R = 200\text{ V}$	-	50	-	pF
Series inductance	$L_S$	Measured from A-lead to K-lead 5 mm from package body	-	10	-	nH



<b>DYNAMIC RECOVERY CHARACTERISTICS PER DIODE</b> ( $T_J = 25\text{ }^\circ\text{C}$ unless otherwise specified)							
PARAMETER	SYMBOL	TEST CONDITIONS		MIN.	TYP.	MAX.	UNITS
Reverse recovery time	$t_{rr}$	$T_J = 25\text{ }^\circ\text{C}$	$I_F = 1\text{ A}$ $V_R = 30\text{ V}$ $di_F/dt = 200\text{ A}/\mu\text{s}$	-	-	28	ns
		$T_J = 125\text{ }^\circ\text{C}$		-	34	-	
		$T_J = 25\text{ }^\circ\text{C}$	$I_F = 35\text{ A}$ $V_{RR} = 100\text{ V}$ $di_F/dt = 200\text{ A}/\mu\text{s}$	-	26	-	
		$T_J = 125\text{ }^\circ\text{C}$		-	49	-	
Peak recovery current	$I_{RRM}$	$T_J = 25\text{ }^\circ\text{C}$	$I_F = 35\text{ A}$ $V_{RR} = 100\text{ V}$ $di_F/dt = 200\text{ A}/\mu\text{s}$	-	3.7	-	A
		$T_J = 125\text{ }^\circ\text{C}$		-	8.2	-	
Reverse recovery charge	$Q_{rr}$	$T_J = 25\text{ }^\circ\text{C}$	$I_F = 35\text{ A}$ $V_{RR} = 100\text{ V}$ $di_F/dt = 200\text{ A}/\mu\text{s}$	-	48.7	-	$\mu\text{C}$
		$T_J = 125\text{ }^\circ\text{C}$		-	202	-	

<b>THERMAL - MECHANICAL SPECIFICATIONS</b>							
PARAMETER	SYMBOL	TEST CONDITIONS		MIN.	TYP.	MAX.	UNITS
Thermal resistance, junction to case	$R_{thJC}$	per diode		-	0.8	0.9	K/W
		both legs		-	-	0.45	
Thermal resistance, case to heatsink	$R_{thCS}$	Mounting surface, flat, smooth and greased		-	0.2	-	
Weight				-	5.5	-	g
				-	0.2	-	oz.
Mounting torque				1.2 (10)	-	2.4 (20)	N · m (lbf · in)
Marking device		Case style TO-218		70CRU02			

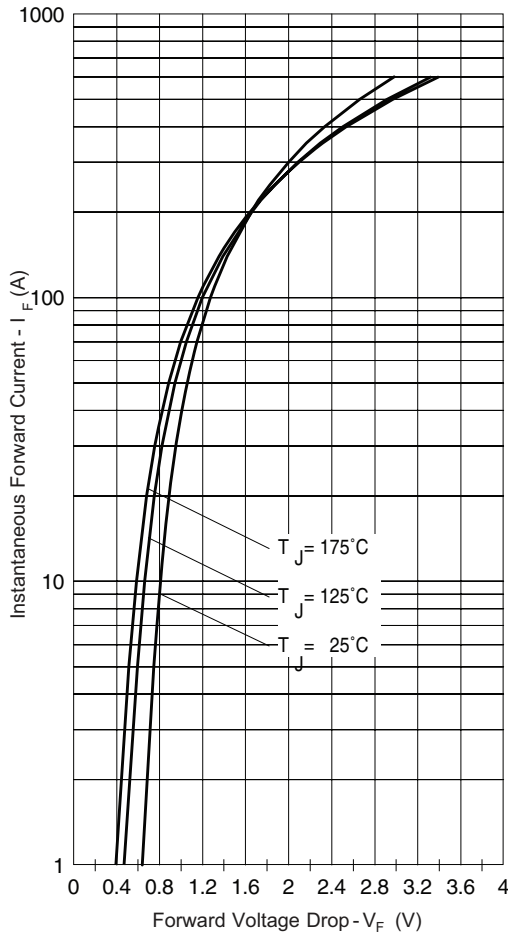

Fig. 1 - Typical Forward Voltage Drop Characteristics (Per Diode)

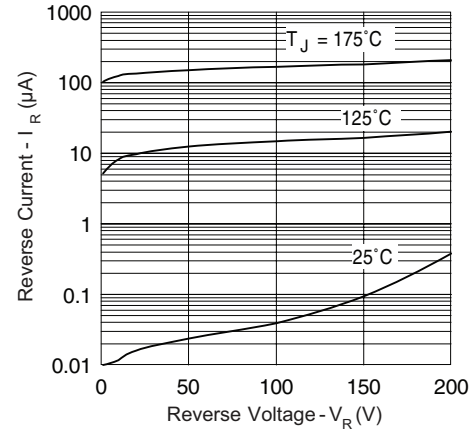

Fig. 2 - Typical Values of Reverse Current vs. Reverse Voltage

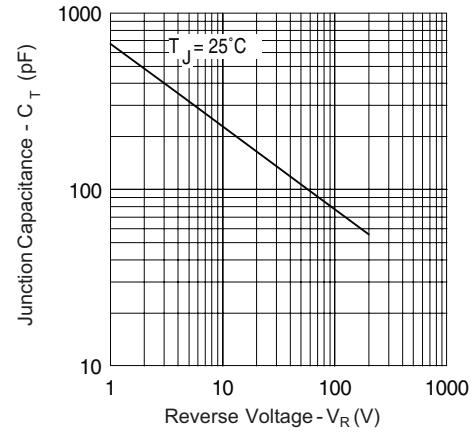
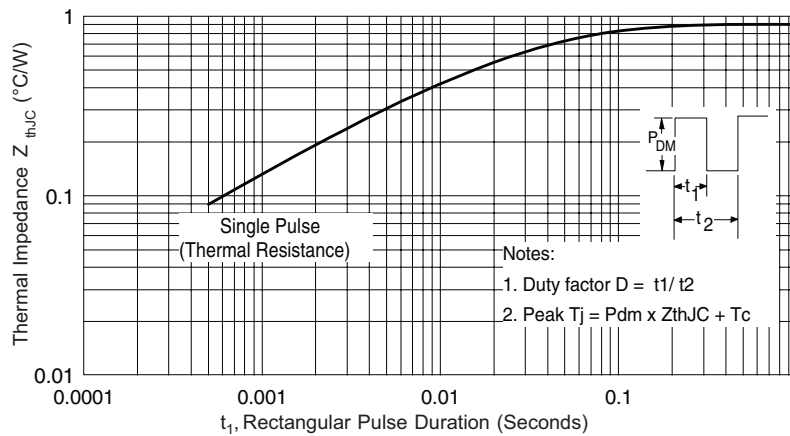

Fig. 3 - Typical Junction Capacitance vs. Reverse Voltage

 Fig. 4 - Maximum Thermal Impedance  $Z_{thJC}$  Characteristics (Per Diode)

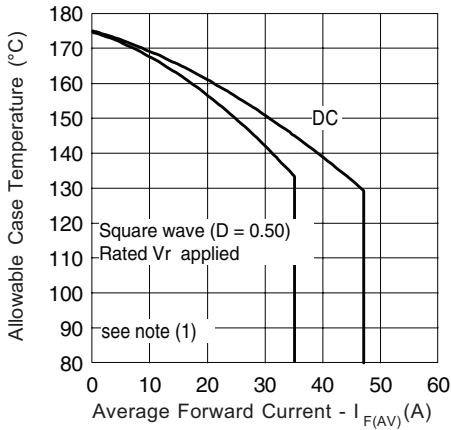

Fig. 5 - Maximum Allowable Case Temperature vs. Average Forward Current

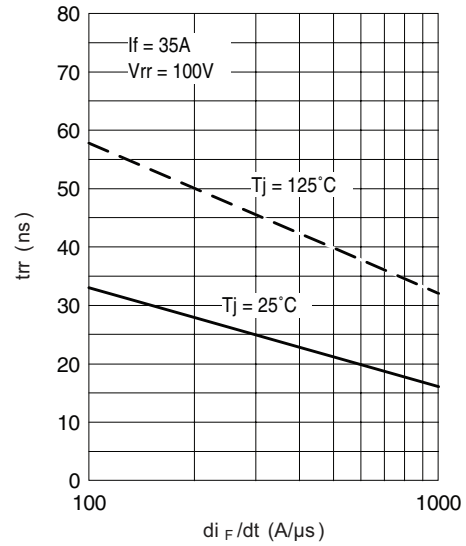

Fig. 7 - Typical Reverse Recovery Time vs.  $di_F/dt$

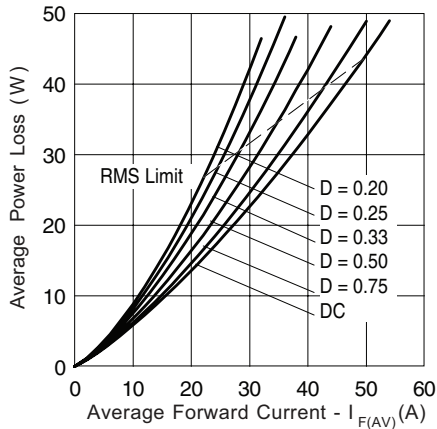

Fig. 6 - Forward Power Loss Characteristics

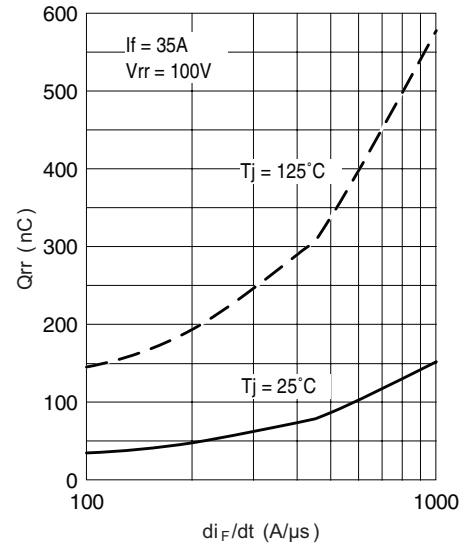

Fig. 8 - Typical Stored Charge vs.  $di_F/dt$

**Note**

- (1) Formula used:  $T_C = T_J - (P_d + P_{d_{REV}}) \times R_{thJC}$ ;  
 $P_d$  = Forward power loss =  $I_{F(AV)} \times V_{FM}$  at  $(I_{F(AV)}/D)$  (see fig. 6);  
 $P_{d_{REV}}$  = Inverse power loss =  $V_{R1} \times I_R (1 - D)$ ;  $I_R$  at  $V_{R1}$  = Rated  $V_R$

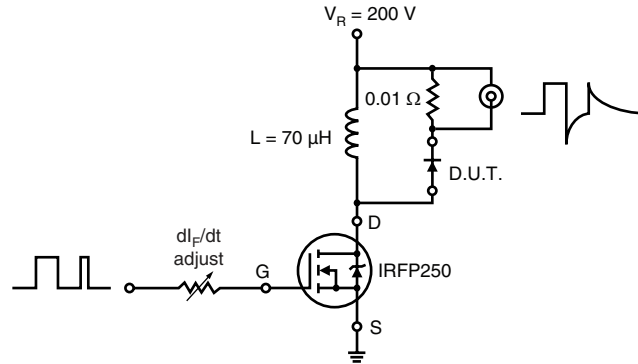
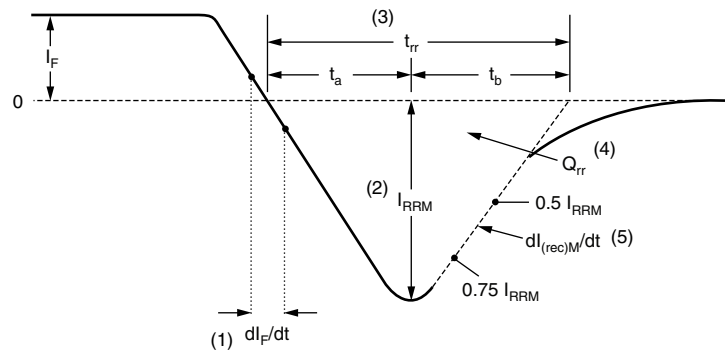

Fig. 9 - Reverse Recovery Parameter Test Circuit



(1)  $di_F/dt$  - rate of change of current through zero crossing

(2)  $I_{RRM}$  - peak reverse recovery current

(3)  $t_{rr}$  - reverse recovery time measured from zero crossing point of negative going  $I_F$  to point where a line passing through  $0.75 I_{RRM}$  and  $0.50 I_{RRM}$  extrapolated to zero current.

(4)  $Q_{rr}$  - area under curve defined by  $t_{rr}$  and  $I_{RRM}$

$$Q_{rr} = \frac{t_{rr} \times I_{RRM}}{2}$$

(5)  $dl_{(rec)M}/dt$  - peak rate of change of current during  $t_b$  portion of  $t_{rr}$

Fig. 10 - Reverse Recovery Waveform and Definitions



## ORDERING INFORMATION TABLE

Device code	<b>70</b>	<b>C</b>	<b>R</b>	<b>U</b>	<b>02</b>	<b>-</b>
	①	②	③	④	⑤	⑥

- 1** - Current rating (70 = 70 A)
- 2** - Common cathode
- 3** - TO-218
- 4** - Ultrafast recovery
- 5** - Voltage rating (02 = 200 V)
- 6** -
  - None = Standard production
  - PbF = Lead (Pb)-free

Tube standard pack quantity: 30 pieces

LINKS TO RELATED DOCUMENTS	
Dimensions	<a href="http://www.vishay.com/doc?95214">http://www.vishay.com/doc?95214</a>
Part marking information	<a href="http://www.vishay.com/doc?95219">http://www.vishay.com/doc?95219</a>



## Disclaimer

All product specifications and data are subject to change without notice.

Vishay Intertechnology, Inc., its affiliates, agents, and employees, and all persons acting on its or their behalf (collectively, "Vishay"), disclaim any and all liability for any errors, inaccuracies or incompleteness contained herein or in any other disclosure relating to any product.

Vishay disclaims any and all liability arising out of the use or application of any product described herein or of any information provided herein to the maximum extent permitted by law. The product specifications do not expand or otherwise modify Vishay's terms and conditions of purchase, including but not limited to the warranty expressed therein, which apply to these products.

No license, express or implied, by estoppel or otherwise, to any intellectual property rights is granted by this document or by any conduct of Vishay.

The products shown herein are not designed for use in medical, life-saving, or life-sustaining applications unless otherwise expressly indicated. Customers using or selling Vishay products not expressly indicated for use in such applications do so entirely at their own risk and agree to fully indemnify Vishay for any damages arising or resulting from such use or sale. Please contact authorized Vishay personnel to obtain written terms and conditions regarding products designed for such applications.

Product names and markings noted herein may be trademarks of their respective owners.